

A Novel Scheme of Fault Identification and Classification Using ANN and Wavelet Transform

Ashish Kumar¹, Puja Bharti², M.A. Ansari³ and Y.K. Chauhan⁴

^{1,2,3,4}Gautam Buddha University

E-mail: ¹ashishelectrical025@gmail.com, ²pujabharti025@gmail.com

Abstract—In the Modern time, there are several technique for identification and classification of fault in the power system. This paper Artificial Neural Network (ANN) are used for identification of faults and with the help of wavelet transform classification of faults. For identification of faults are depends on some parameter like regression, performance (mean square error) and validation check in the ANN whereas, for classification of faults are based on the energy of current data. All the parameters for identification are based on current. Mostly, Line faults occurs in the Overhead transmission and distribution line. The faults are symmetrical and unsymmetrical in which symmetrical faults consists of three phase fault and unsymmetrical faults contains three type namely- Single line to ground (SLG), Double line to ground (DLG), Line to line (LL). The most common faults are Single line to ground fault in overhead lines.

1. INTRODUCTION

Overhead transmission and distribution lines are mostly found in the India in which line faults are occurs, mostly. So, apply the techniques for remove the line faults from the system. There are several technique for this. But, in this paper discussed about the two technique namely, artificial neural network and Wavelet transform. With the help of artificial neural network, identification of faults are basis on their pattern and numeric value. Wavelet transform helps us to classification of faults by finding the energy. Faults are basically two type symmetric and unsymmetrical. Symmetric faults are also called balanced or three phase faults because after the faulty situation, its remains in balanced condition [1]. Unsymmetrical faults are called as the unbalanced faults. Unbalanced faults are three type. Single line to ground (SLG) faults, Double line to ground (DLG) faults, Line to line (LL) faults. Single line to ground faults are mostly common and it occurs 65-70 percent. When conductor of one phase touches with the ground then SLG faults occurs. Double line to ground (DLG) faults are occur 15-20 percent. When conductor of two phase are touch with the ground then DLG faults are occur. Line to line (LL) fault occurs 5-10 percent. When two phase conductor are touch each other. This type of faults are occur in the wide wind season [2]. Simulate the power system proposed model in the Simulink and on the current parameter

basis clear the faults as soon as possible when the fault are occur.

2. IDENTIFICATION OF FAULTS USING ARTIFICIAL NEURAL NETWORK

Artificial Neural Network are help us to identification of faults. Neural Network are trained the data (current data) and finds the regression plot and performance plot (mean square error). It also gives the numeric value which helps for identification. ANN works on the back propagation algorithm and for trains the data use the Levenberg- Marquardt (trainlm) [3]. ANN are pattern recognition nature which helps in identification of faults. ANN have a supervised learning which works as an open loop. In the open loop system, the input patterns are basis on output patterns [4]. Output data depends upon the input data [5]. It means when the faults are occur their pattern comes as the output. So, the Levenberg-Marquardt algorithm as followed:

Jacobian jP are calculated by the Back Propagation and Bias variable denotes the P.

$$jj = jP * jP \quad (1)$$

$$je = jP * E \quad (2)$$

$$dP = \frac{-(jj * I * mu)}{je} \quad (3)$$

E denotes the error and I denotes the identity matrix. This algorithm take more space data as compare to other algorithm but give the result accurate [6].

3. CLASSIFICATION OF FAULT USING WAVELET TRANSFORM

Wavelet transform decomposed the signal into two components. For the decomposition uses the suitable wavelet and suitable level for any signal. Decomposition helps to filter

the signal like the low pass and high pass filter [7]. In this paper, (sym) Symlet wavelet are use at the level 8. Due to this decompose the signal and it divide the signal in Approximate and Detail Coefficient.so, finds the energy of the current parameter [8]. On the basis of the energy of current are classify the faults. When any faults are occur then their value becomes 1 and there is no faults then their output is 0 [9]. From this basis, Classification of faults are occur with the help of energy of current [10].

4. DESIGN OF FLOW CHART OF FAULT IDENTIFICATION AND CLASSIFICATION

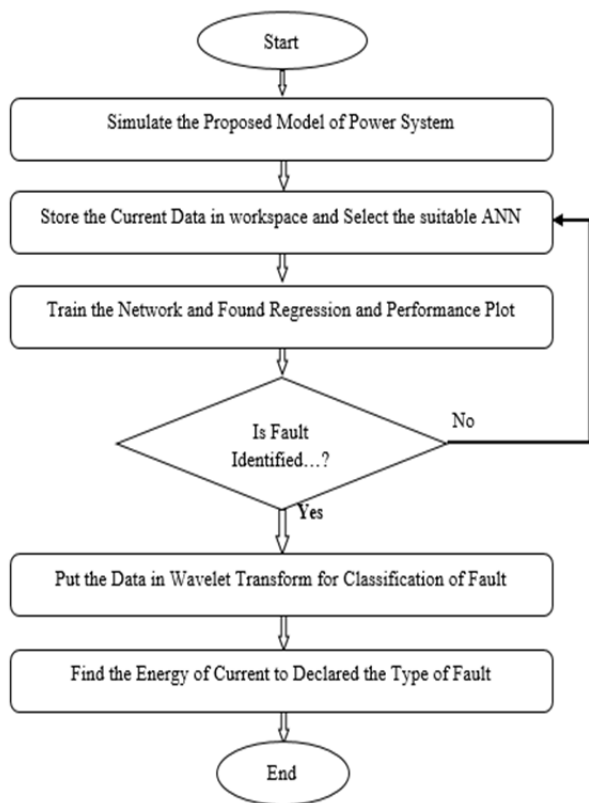

Fig. 1: Flow Chart for Identification and Classification of faults in the power system.

5. SIMULATION OF PROPOSED MODEL OF POWER SYSTEM

There are six bus and six generator. Bus1 is Reference bus and from Bus 2 to 6 all are generator bus. Three phase fault block are connected in between bus 2 and bus 3. All the faults calculation are on the current basis.

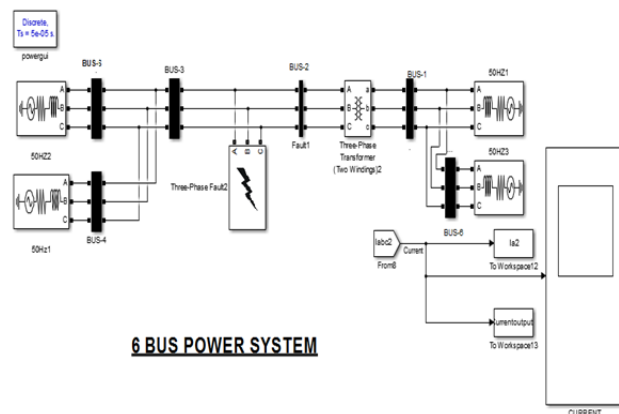

Fig. 2: Proposed Model for Fault Identification and Classification.

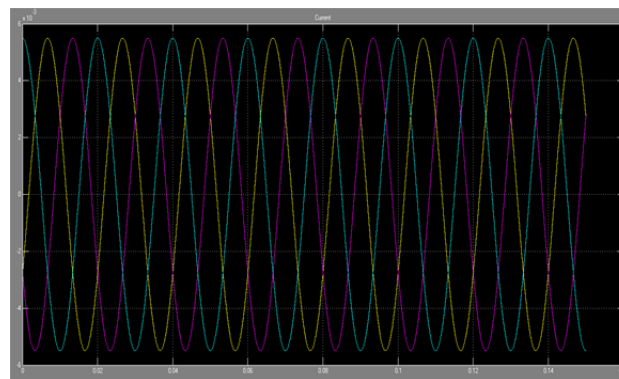

Fig. 3: Current waveform (Without fault) [Ia=Ib=Ic].

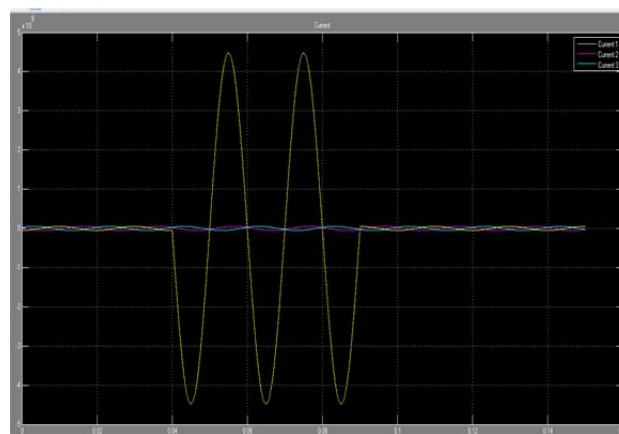

Fig. 4: Current waveform (SLG fault) [Ia_max > Ib_max, Ic_max].

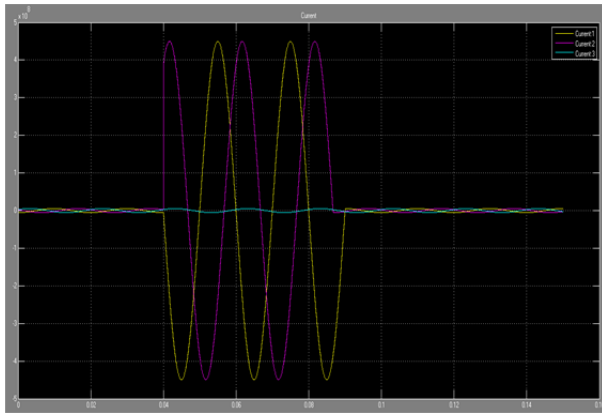

Fig. 5: Current waveform (DLG fault) [$I_{a_{max}} = I_{b_{max}} > I_{c_{max}}$].

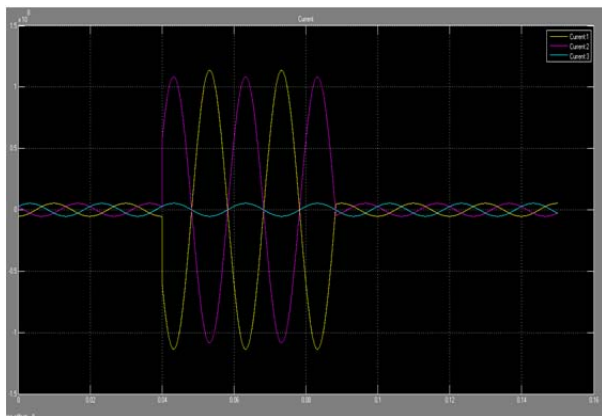

Fig. 6: Current waveform (LL fault) [$I_{a_{max}} = I_{b_{max}} > I_{c_{max}}$]

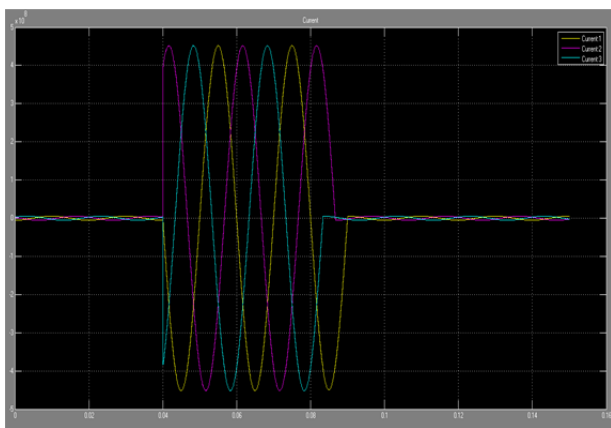

Fig. 7: Current waveform (Three phase fault) [$I_{a_{max}} = I_{b_{max}} = I_{c_{max}}$]

Fig. 3 shows the normal condition means, there is no fault. Fig.4 to 7 all these plots show the variation in the current waveform. Variation in the plot, shows that there is fault and for identification use the ANN and for classification of fault on the basis of energy of current in the wavelet transform.

6. RESULTS AND DISCUSSION

In the ANN, There are plot of trained data in which it gives the result in the terms of Regression plot and Performance. All type of faults identification on their pattern. Different type of faults have different type of structure. On this basis, Identification of fault are occurs.

6.1 Without Fault

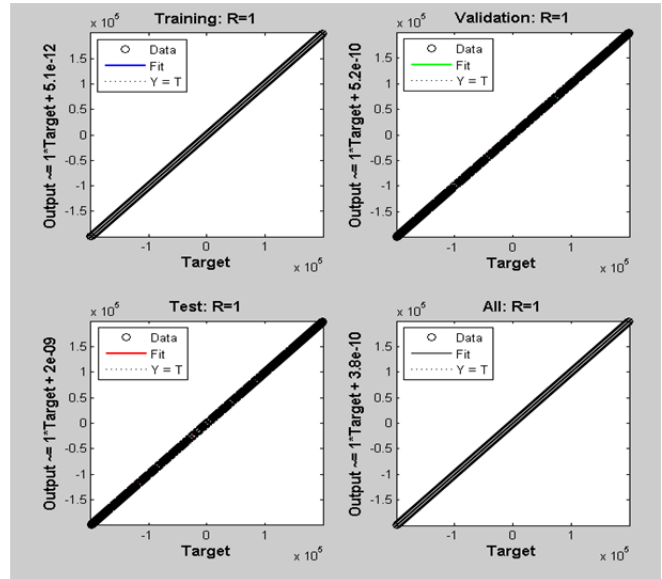

Fig. 8: Regression Plot of Without Fault

In the Regression plot value of $R=1$ for training, validation and test. Slop of graph makes 45° .

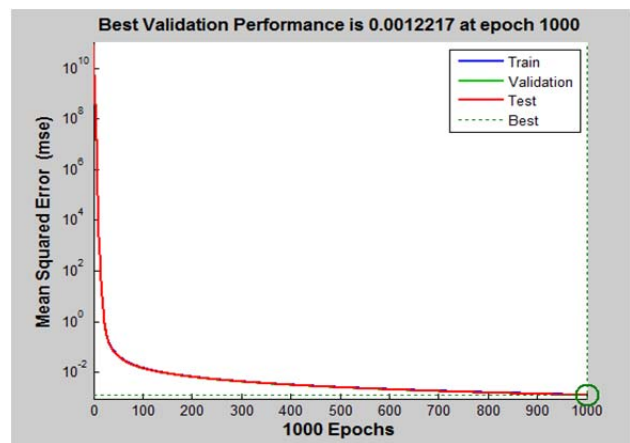

Fig. 9: Performance plot (Mean Square Error) of Without Fault

In the performance plot, Training, testing and validation are meet at each other at every point and epoch is 1000. So, Regression and Performance plot tell about that there is no fault. It comes under normal condition.

6.2 SLG Fault

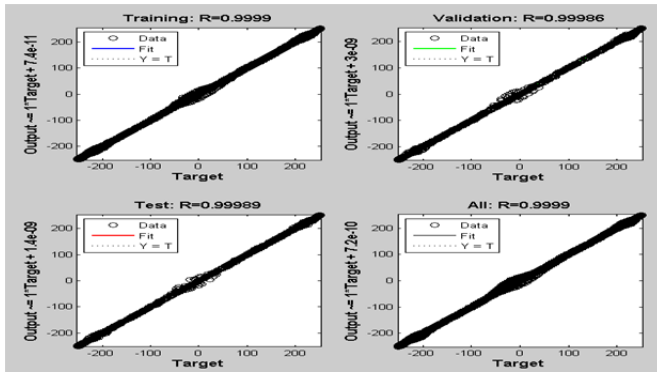

Fig. 10: Regression Plot of SLG Fault

In the Regression plot value of $R \neq 1$ for training, validation and test. Slope of graph does not make 45° .

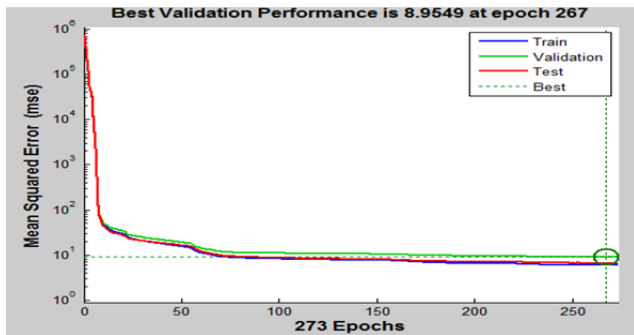

Fig. 11: Performance plot (Mean Square Error) of SLG Fault

In the performance plot, Training, testing and validation are not meet at each other at every point and epoch is 267. So, Regression and Performance plot tell about that there is fault. It comes under abnormal condition.

6.3 DLG Fault

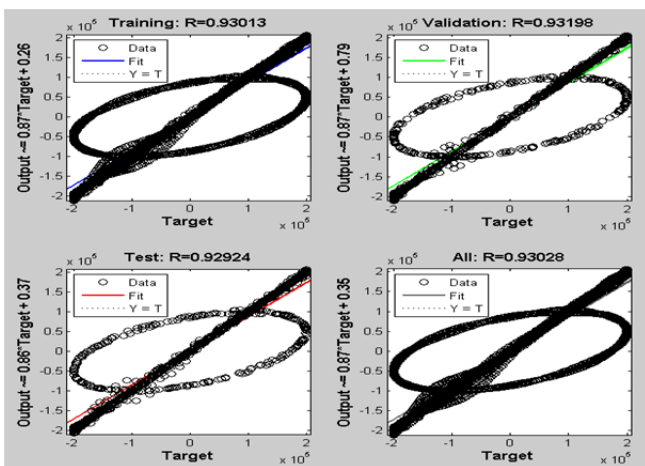

Fig. 12: Regression Plot of DLG Fault

In the Regression plot value of $R \neq 1$ for training, validation and test. Slope of graph does not make 45° .

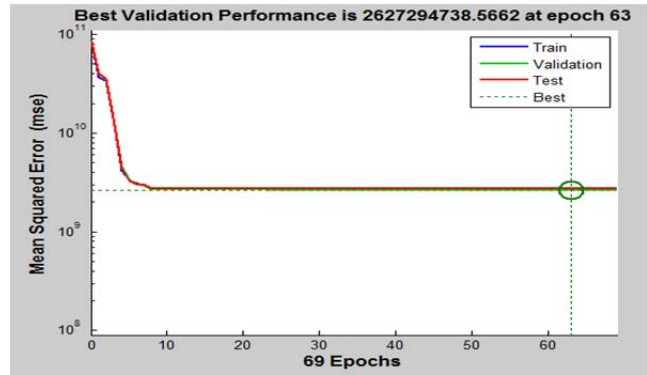

Fig. 13: Performance plot (Mean Square Error) of DLG Fault

In the performance plot, Training, testing and validation are not meet at each other at every point and epoch is 63. So, Regression and Performance plot tell about that there is fault. It comes under abnormal condition.

6.4 LL Fault

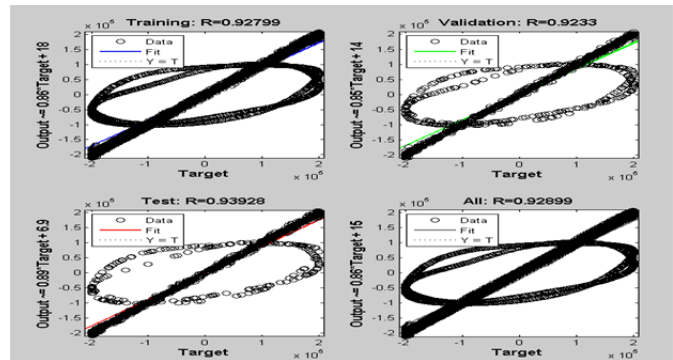

Fig. 14: Regression Plot of LL Fault

In the Regression plot value of $R \neq 1$ for training, validation and test. Slope of graph does not make 45° .

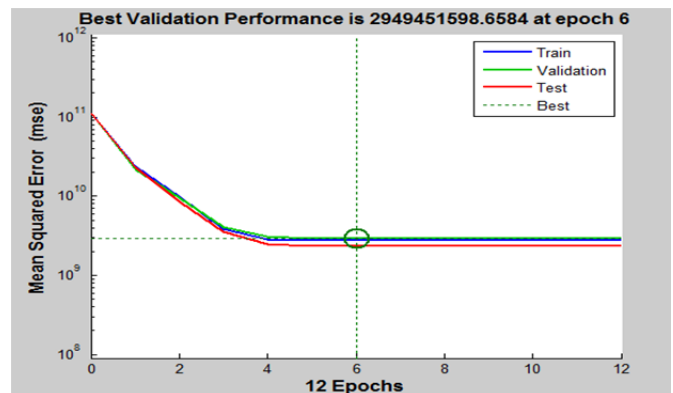

Fig. 15: Performance plot (Mean Square Error) of LL Fault

In the performance plot, Training, testing and validation are not meet at each other at every point and epoch is 6. So, Regression and Performance plot tell about that there is fault. It comes under abnormal condition.

6.5 Three Phase Fault

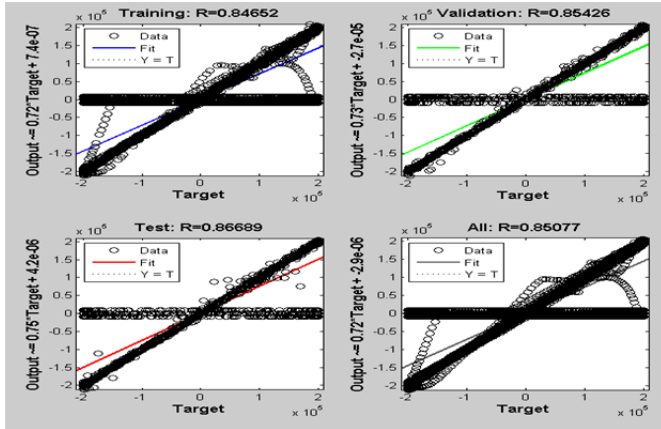

Fig. 16: Regression Plot of Three Phase Fault

In the Regression plot value of $R \neq 1$ for training, validation and test. Slop of graph does not make 45° .

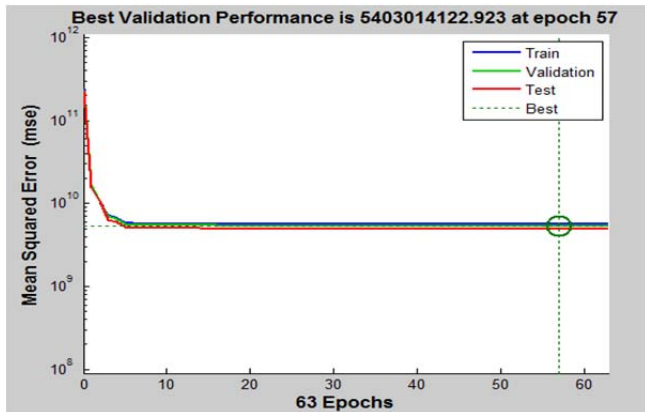

Fig. 15: Performance plot (Mean Square Error) of LL Fault

In the performance plot, Training, testing and validation are not meet at each other at every point and epoch is 6. So, Regression and Performance plot tell about that there is fault. It comes under abnormal condition.

Table 1: Classification of fault on the basis of energy of current in wavelet transform

Type of Fault	Phase	Energy of Current Output			
		A	B	C	G
SLG	AG	1	0	0	1
SLG	BG	0	1	0	1
SLG	CG	0	0	1	1
DLG	ABG	1	1	0	1
DLG	BCG	0	1	1	1
DLG	CAG	1	0	1	1

LL	AB	1	1	0	0
LL	BC	0	1	1	0
LL	CA	1	0	1	0
Three Phase	ABC	1	1	1	0

In the Table 1, Type of faults are classified with the help of energy of current waveform by wavelet transform. Energy of current waveform are shown in table and by this classification of faults. In the wavelet transform, Data is taken from of workspace in form of array. When there is faults in any phase or ground then its shows 1 whereas for without faults or normal condition shows the value 0. Energy of current output shows the phase value “0 or 1”. From this, Classification of faults are there as well as Phase of conductor also be known. Three phase denotes “A, B, C,” and “G” denotes the Ground. Energy of current comes 1 and 0 because it converted into binary number. Binary number helps to classify the fault. From all this parameter, Classification and Identification of Faults are possible. After Classification remove the faults from the system and make the system in the normal form. Identification of faults with the help of ANN whereas Classification of faults with the help of Wavelet Transform. Energy of current are in the “0 or 1” because from this parameter known about the phase of conductor as well type of faults.

7. CONCLUSION

On the basis of current parameter, the identification and classification are done with the help of ANN and Wavelet Transform. ANN helps to identification of fault by regression plot and mean square error whereas Wavelet transform helps to finds the energy for classification of faults in the power system. ANN deals with the neurons and wavelet transform deals with the signal. Line faults are occur in overhead transmission and distribution line, mostly. Current parameter generally used for line faults because line fault occurs then current variation is more as compare to other. After classification of faults, clear the faults as soon as possible to save our electrical equipment’s. All the protection equipment’s for line faults are current sensing.

8. ACKNOWLEDGMENTS

We are very thankful to the Department of Electrical Engineering, School of Engineering, and Gautam Buddha University for providing the Research facilities and the necessary support to carry out this work.

REFERENCES

[1] M F Othman, M Mahfouf and D A Linkens, “Transmission Lines Fault detection, classification and location using an intelligent Power system stabilers”, *IEEE International Conference on Electic Utility Deregulation, Restructuring and Power Technologies*, pp. 360-365 (DRPT2004), Hong Kong, April 2004.

-
- [2] Badri Ram and D N Vishwakarma, "Power System Protection and Switchgear", *Tata McGraw Hill*, 2nd Edition, 2007.
 - [3] Eisa Bashier M. Tayeb Orner and A Aziz A Rhim, "Transmission Line Faults Detection, Classification and Location using Artificial Neural Network", *IEEE* 978-1-4673-6008-11111, 2012.
 - [4] S N Sivanandam and S N Deepa, "Principle of soft Computing. Wiley" *Indian Edition*, 2nd Edition, 2006
 - [5] Ebha Koley, Anamika Jain, A.S.Thoke and Abhinav Jain, "Detection and Classification of fault on six phase Transmission Lines Using ANN", *International Conference on Computer and Communication Technology (ICCCCT)*, 978-1-4577-138611, 2011.
 - [6] Math works Inc USA, "Neural Networks Toolbox", 2006.
 - [7] Julio Cesar Stacchini de Souza, A.P. Rodrigues, Marcus Theodor Schilling and Milton Brown Do Coutto Filho, "Fault Location in electrical power system using intelligent systems Techniques", *IEEE Trans. On Power Delivery*, Vol- 16, No-1, pp.59-67, Jan 2001.
 - [8] The Math Works Inc.USA, "Wavelet toolbox manual-user's guide", March 1966.
 - [9] K.M. Silva, B.A.Souza and N.S.D.Brito, "Fault Detection and classification in transmission in transmission lines based wavelet transform and ANN", *IEEE Trans. On Power Delivery*, Vol- 21, No-4, pp.2058-2063, Oct2006.
 - [10] Mayuresh Rao and R.P. Hasabe, "Detection and Classification of Faults on Transmission Line Using Wavelet and Neural Network", *International Journal of Advanced Electrical and Electronics Engineering (IJAEED)*, Vol-2, Issue-5, pp. 2278-8948, 2013.